



Pallet Racking



## Intelligent storage solutions

Supply chains must function efficiently. Whether handling pallets of fruit, containers of hazardous materials, racks of clothing or boxes of nails; products still need to be handled in a safe and efficient manner. Personnel must also be able to work safely and effectively too. Our storage systems live up to expectations and allow you to run your business smoothly and successfully.





### **Forty years of expertise**

NEDCON has been a worldwide leader in storage systems for more than forty years. And as result, we possess a great deal of specialized knowledge. This knowledge we use to continuously improve our systems and would like to share this knowledge with you.

### **Always a complete solution**

Warehouses that run smoothly must be efficient, safe and user-friendly. And that is where we are able to help you. We offer you a smart standard range of products that provides you with a solution for all of your storage requirements and challenges. Of course, our systems also guarantee the utmost in quality and safety.

### **International player**

NEDCON is an independent company that has been part of the international steel group **voestalpine** since 2004. We are based in Doetinchem and our production activities take place in Pardubice (Czech Republic). In addition, we also have divisions in various European countries as well as in the United States. Our products are also sold via a dealer network.



## Pallet racks

### Answers to your storage requirements

A manually operated warehouse? Or an automated solution?

NEDCON has the pallet rack that is best for your operation.

Thanks to our modular design and our extensive selection of profiles, we are certain to always find an answer to your storage requirements.

### Quick delivery times

Does your business utilize the most common pallets, such as Euro, Block or Chep pallets? Then we guarantee you an extremely short delivery time. The fact is, thanks to our stock of standard components we are able to meet 98% of the market demands without a problem. And if your components have to be custom made? Then we guarantee and deliver acceptable delivery times. No matter which pallet rack you choose we stand behind the delivery reliability, service and quality of each and every one.

## Safety and ease-of-use

You can count on the fact that our pallet racks are safe. We always work according to the European standards and safety regulations, including EN 15512 with any additional national standards, if applicable. In addition to this excellent standard of safety, our racks are also user friendly. They are extremely easy to combine with floors, roll-through racks and other types of racks. You can choose your own colour or choose one of the standard colours (Capri blue RAL 5019 for the beams and Red-orange RAL 2008 for the girders).

## NEDCON makes a difference

Our product is well-established in the market, which can be shown by countless realizations with virtually no complaints. NEDCON offers the largest range of uprights and beams in the business, which allows us to always find an optimum solution for you. NEDCON is known for the best performing beam-to-upright connectors allowing us to build rigid racks without bracing even in the most difficult conditions. The surfaces of main components are epoxy-coated, which ensures protection of the highest quality.





### **Diagonal connection to the upright**

The junction in the frame between an upright and 2 full width diagonals are bolted. The ends of the diagonals are fitted with a bend part to avoid deformation by the bolt connection.

This joint being symmetrical, the uprights will not twist under the effect of horizontal forces.



### **Special Baseplate**

The upright profile transmits a point-load on the floor via the base plate. The dimension, type of steel, material thickness and any extra pressure all play a role in determining the distribution of the plates to ensure sufficient spreading of this point load.

NEDCON uses two anchor bolts, one on either side of the upright so that if struck torsional damage is greatly reduced. The distance between the anchors is on purpose enlarged in order to ensure maximum resistance of the connection to vertical and horizontal loads.



### **Safety Protection**

The corners and sides of a rack block are vulnerable places for damage caused by collisions. Corner protectors accommodate impacts and protect the corner uprights. A combination of sigma profile and corner protectors provides substantial protection to end frames.

Energy absorbing rubber anchor blocks ensure that even if the corner protectors are damaged the concrete floor remains intact. This allows easy replacement with minimal disruption to the operation.

### **Special safety pin**

The safety pin has two functions: Due to its solid size with a diameter of 10 mm, the safety pin fits into the upright perforation with a minimum clearance. This ensures that during assembly of the racking the beam is always mounted in the correct manner. Secondly, the solid safety pin prevents the hook-in connectors being dislodged by any upward force during handling operations in the warehouse.

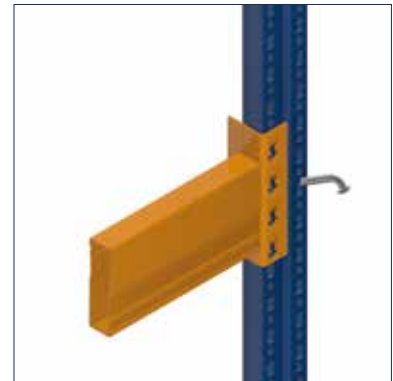



## Hook-in connectors

Three versions of the hook-in connectors allow us to always find the optimum and most cost-effective solution.

Hook-in connectors made of high-quality micro-alloy steel have higher properties than using standard steels

The unique shape of the connector results in the strongest and stiffest connection available, which allows building highly rigid racks without bracing and in heavy seismic areas if applicable.

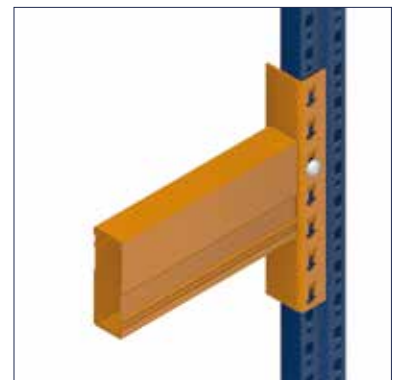
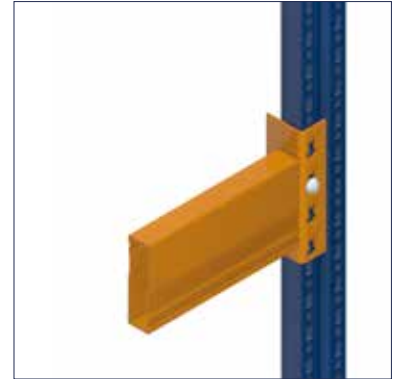

# Intelligent solutions for all warehouses

## **We supply not just a Product, but a Solution**

When solving your storage problem we apply a personal approach. You will be given competent advice by industry professionals. You can choose whether you prefer a smart standard solution available directly from stock or a fully customized solution.

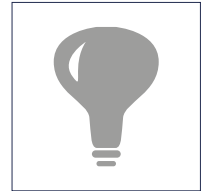

## **We minimize Costs over a Lifetime**

We think together with you and minimize your total costs of running a storage facility. Be it a design of optimum rack protection or advice on configurations ensuring maximum throughput through the warehouse, we have your total costs on our mind.



## **We consistently deliver what we promise**

NEDCON is known as a trustworthy partner. Despite the circumstances we make things happen and we always deliver what we promise.



## **Quick Response Times**

Standard solutions are prepared within days.

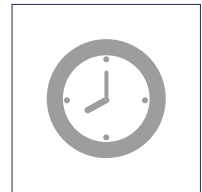

### **Extensive Expertise of NEDCON Team**

We are the people who were able to build in the past four decades the most complex systems in the business. We understand the storage industry and we are here should you be in need.



### **Unconditional Approach to Safety**

The unconditional approach to safety forms the basic building stone in 100% of our designs! All our components are laboratory tested to the latest standards. NEDCON for decades has been the leader in the development of European industry regulations.

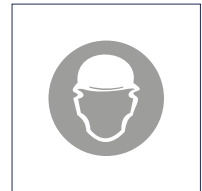

### **First-class Product**

Our products are well-established in the market and have been used in countless realizations all over the world. NEDCON clients often comment positively on the premium quality and reliability of our systems.

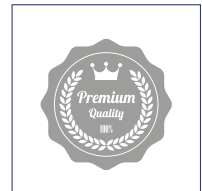

### **User friendliness**

Warehouses equipped with NEDCON products are easily maintained and damaged parts are simply replaced if necessary. Over time should your storage solution require a modification or an extension, our flexible systems and experienced teams are prepared to satisfy your needs.

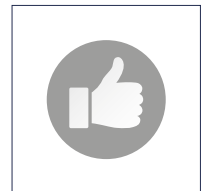

Certified  
and safe

We are fully certified for your safety. We possess the following certificates:

- ISO 9001
- ISO 14001
- EN 1090
- DIN 18800-7 version E





## Offices

### The Netherlands

NEDCON Magazijnrichting B.V.  
Nijverheidsweg 26  
7005 BJ Doetinchem  
P.O. BOX 35  
NL-7000 AA Doetinchem  
T +31 314 334455  
E [info@nedcon.com](mailto:info@nedcon.com)

### Germany

NEDCON Lagertechnik GmbH  
Dinxperloer Straße 18-20  
46399 Bocholt  
T +49 2871 47 89  
E [sales.d@nedcon.com](mailto:sales.d@nedcon.com)

### USA

NEDCON USA Inc.  
10053 Simonson Road, Suite 1  
Harrison OH 45030  
T +1 513 367 2656  
E [sales.usa@nedcon.com](mailto:sales.usa@nedcon.com)

### France

NEDCON France SAS  
Immeuble Saphir  
5, Rue du Parc  
67205 Oberhausbergen  
T +33 3 88 560 555  
E [sales.fr@nedcon.com](mailto:sales.fr@nedcon.com)

### Czech Republic

NEDCON Bohemia, s.r.o.  
Holandská 34  
53301 Pardubice  
T +420 467 002 111  
E [info.cz@nedcon.com](mailto:info.cz@nedcon.com)

### Belgium (Sales)

NV NEDCON S.A.  
Diamantstraat 6  
2200 Herentals  
T +32 14 24 19 80  
E [sales.b@nedcon.com](mailto:sales.b@nedcon.com)

### Poland (Sales)

NEDCON Silesia SP. z.o.o.  
Ul. w. Antoniego 15  
55-073 Wrocław  
T +48 71 7804271  
E [sales@nedcon.pl](mailto:sales@nedcon.pl)

## Notes





# NEDCON



Do you want to  
see more? Scan this  
QR-code with your  
Smartphone

